

SPECIFICATIONS:

PART NUMBER:
HG2TAHSP-XX-XX
(Ex: Single Color Blue/Red: HG2TAHSP-BR-XX)
(Ex: Dual Color Blue/Red With
White Flood: HG2TAHSP-BR-WW)
APPLICATION:
Exterior Use
MOUNTING:
Surface mount (no drilling required)
DIMENSIONS:
Length: 61.100"
Height: 1"
Depth: 5"

INPUT VOLTAGE:
9 - 15 VDC
STAND-BY CURRENT DRAW:
.001A
OPERATING TEMPERATURE:
-4° to 185° F (-20° to 85° C)
CURRENT DRAW:
1.5A Average
1A min. / 3A max. dependent on flash pattern
1A min. / 3A max. dependent on flash pattern
60 5mm High-intensity, wide-angle LEDs

FLASH PATTERNS:
20
CHASSIS:
Black Finish Powder Coated Aluminum Housing
CERTIFICATIONS:
SAE J595 Class 1, Title 13
WARRANTY:
3 Year Warranty

PROUDLY DESIGNED AND MADE IN THE USA.

BLACK	(-) Chassis Ground
RED	(+) 12V Constant Power
WHITE	(+) Switched Power
BROWN	(+) Takedown Power
GREEN	(+) Cruise Mode
BLUE	(+) Momentary Pattern
YELLOW	(+) Right Directional
ORANGE	(+) Left Directional

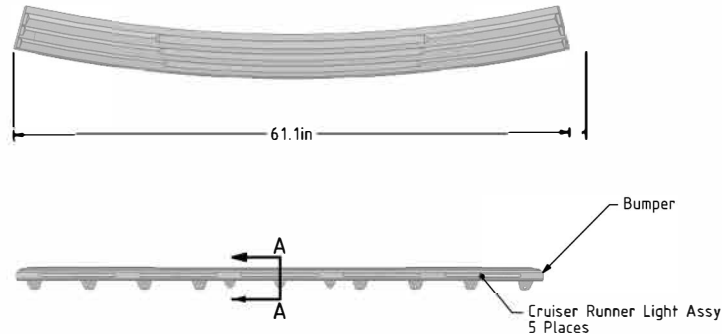

* Please see full wiring diagram for addition information